

LAPPSET®

PARKOUR





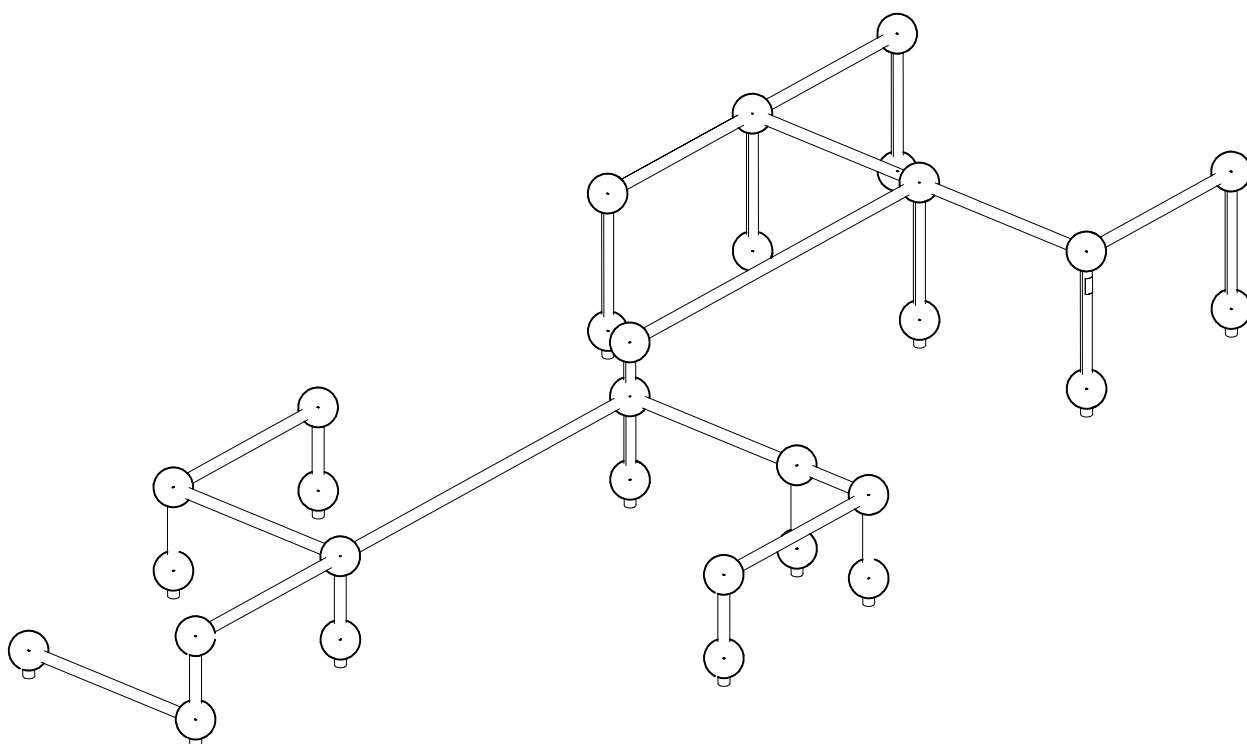

ASENNUSOHJE
MONTERINGSANSVISNING
INSTALLATION INSTRUCTION
AUFBAUANLEITUNG
NOTICE D'INSTALLATION

DATE: 8.2.2013

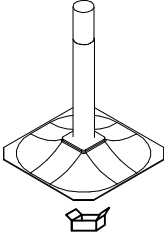
220549

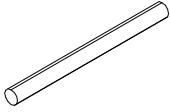
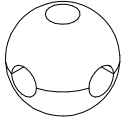

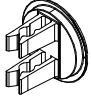
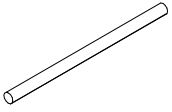
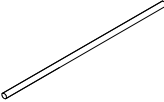
DATE: 8.2.2013

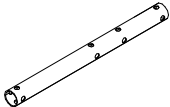
<p>701985</p>  <p>PCS 15</p>	<p>702341</p>  <p>PCS 1</p> <p>90x50</p>	<p>902022</p>  <p>PCS 6</p> <p>L 710</p>	<p>902134</p>  <p>PCS 30</p> 	<p>902157</p>  <p>PCS 107</p> <p>60x60x2</p>	<p>902424</p>  <p>PCS 11</p> <p>L 1034</p>
<p>904130</p>  <p>PCS 2</p> <p>L 2148</p>	<p>904132</p>  <p>PCS 8</p> <p>L 402</p>	<p>904135</p>  <p>PCS 1</p> <p>L 710</p>			

EN Impact Area 45.2 m² (487 sq ft)

Grid Size 1000 mm (40" in)

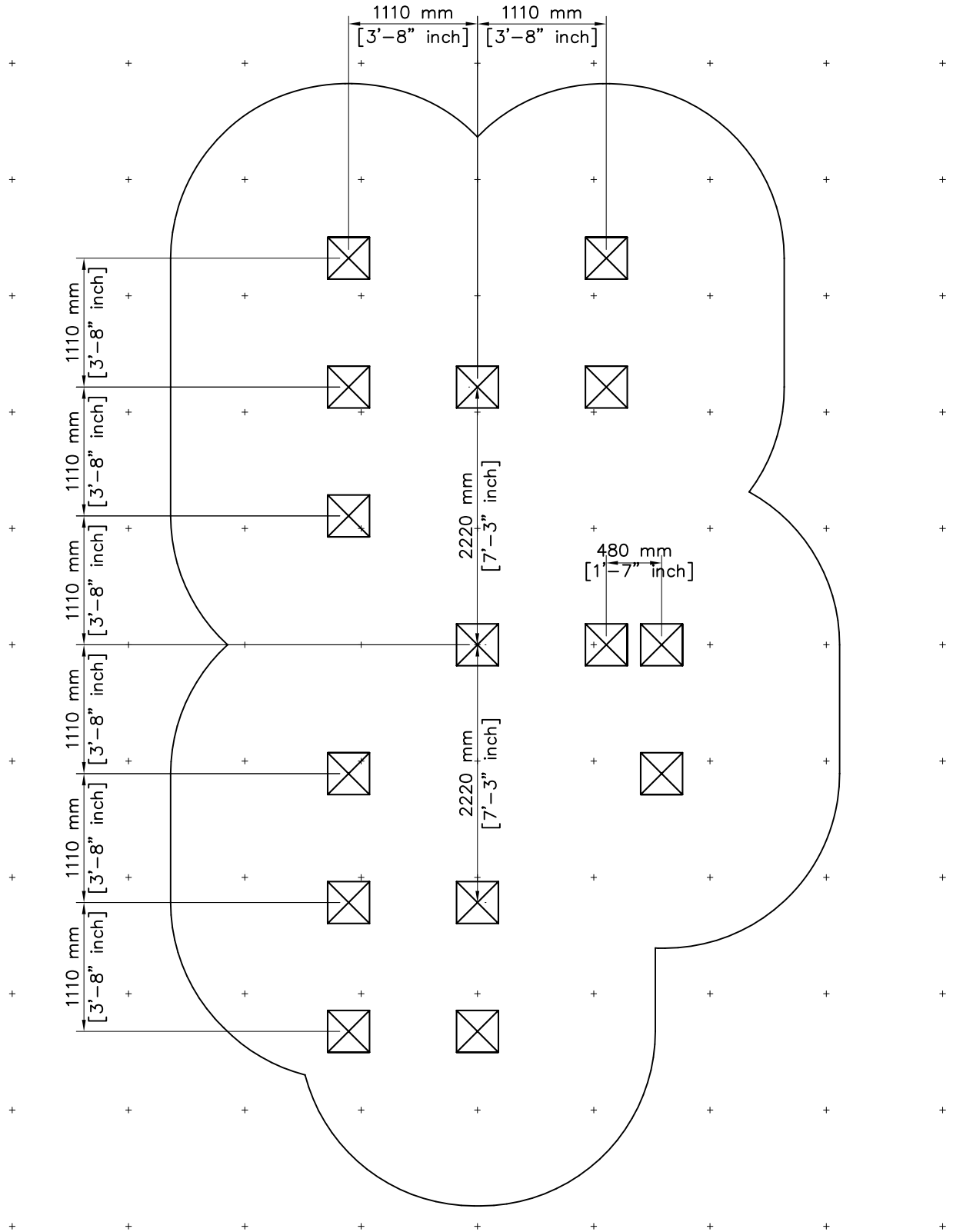
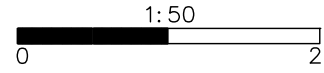

EN Impact Area 45.2 m² (487 sq ft)

Max Falling Height 960 mm (3'-2" in)

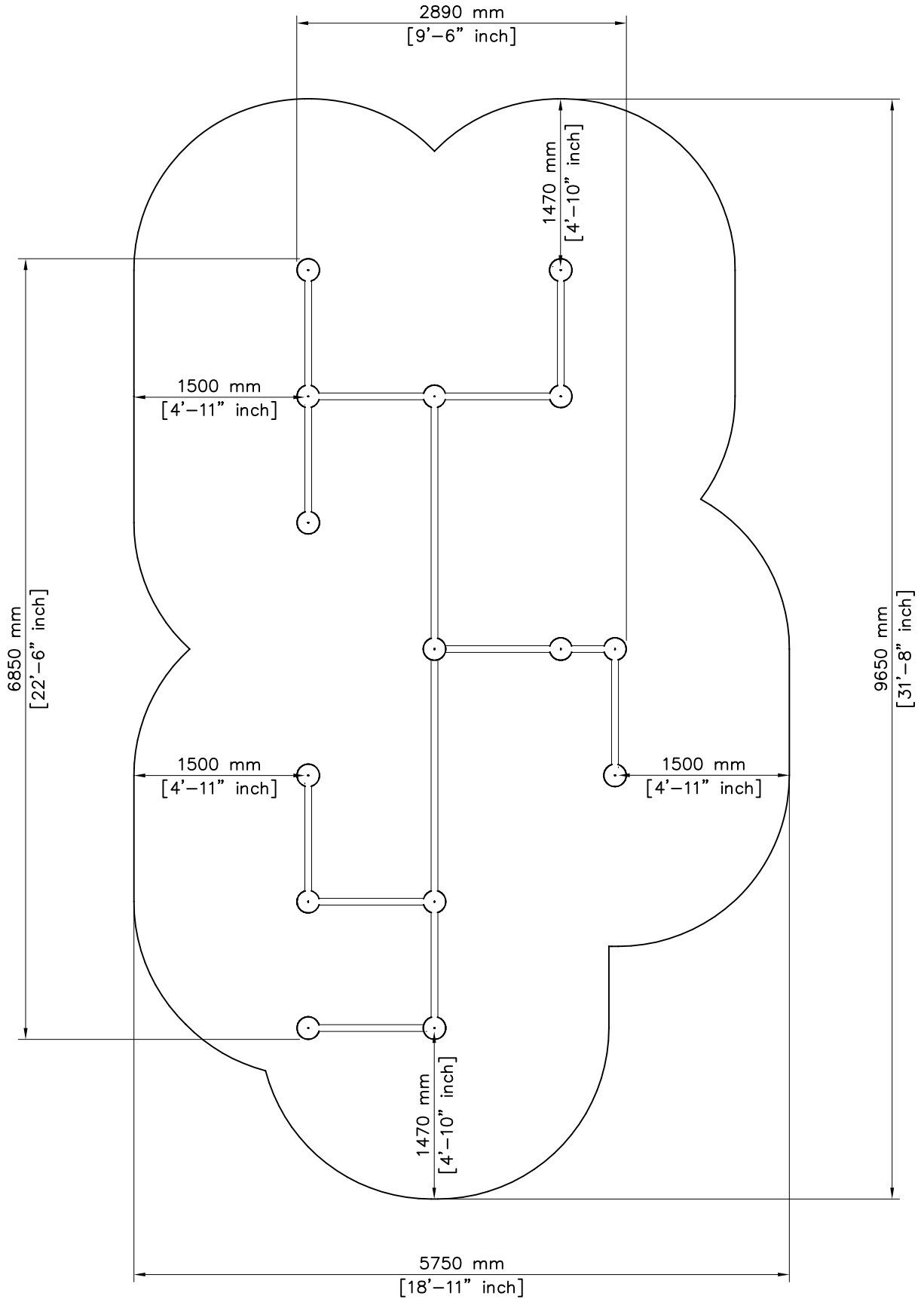
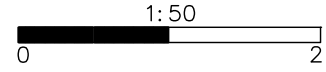

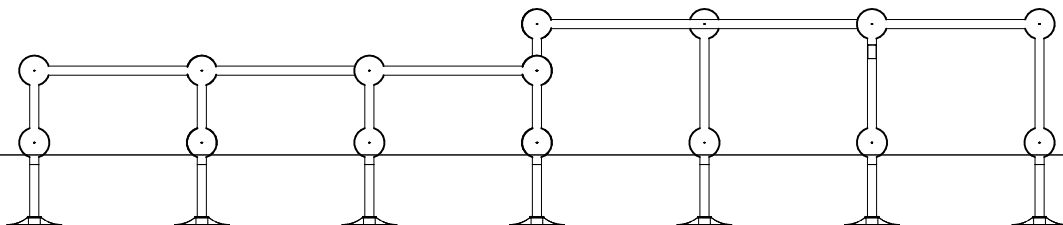
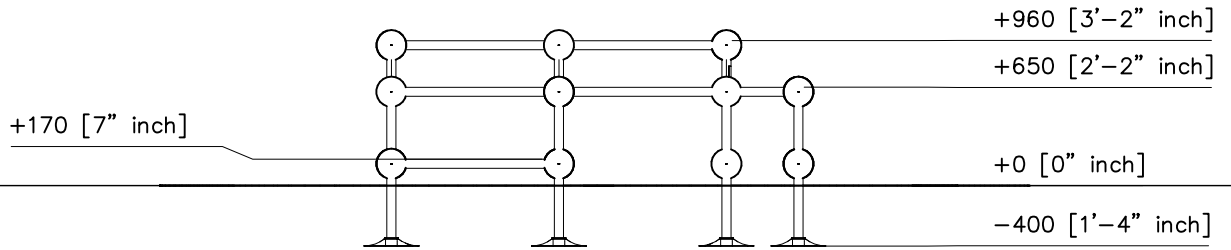

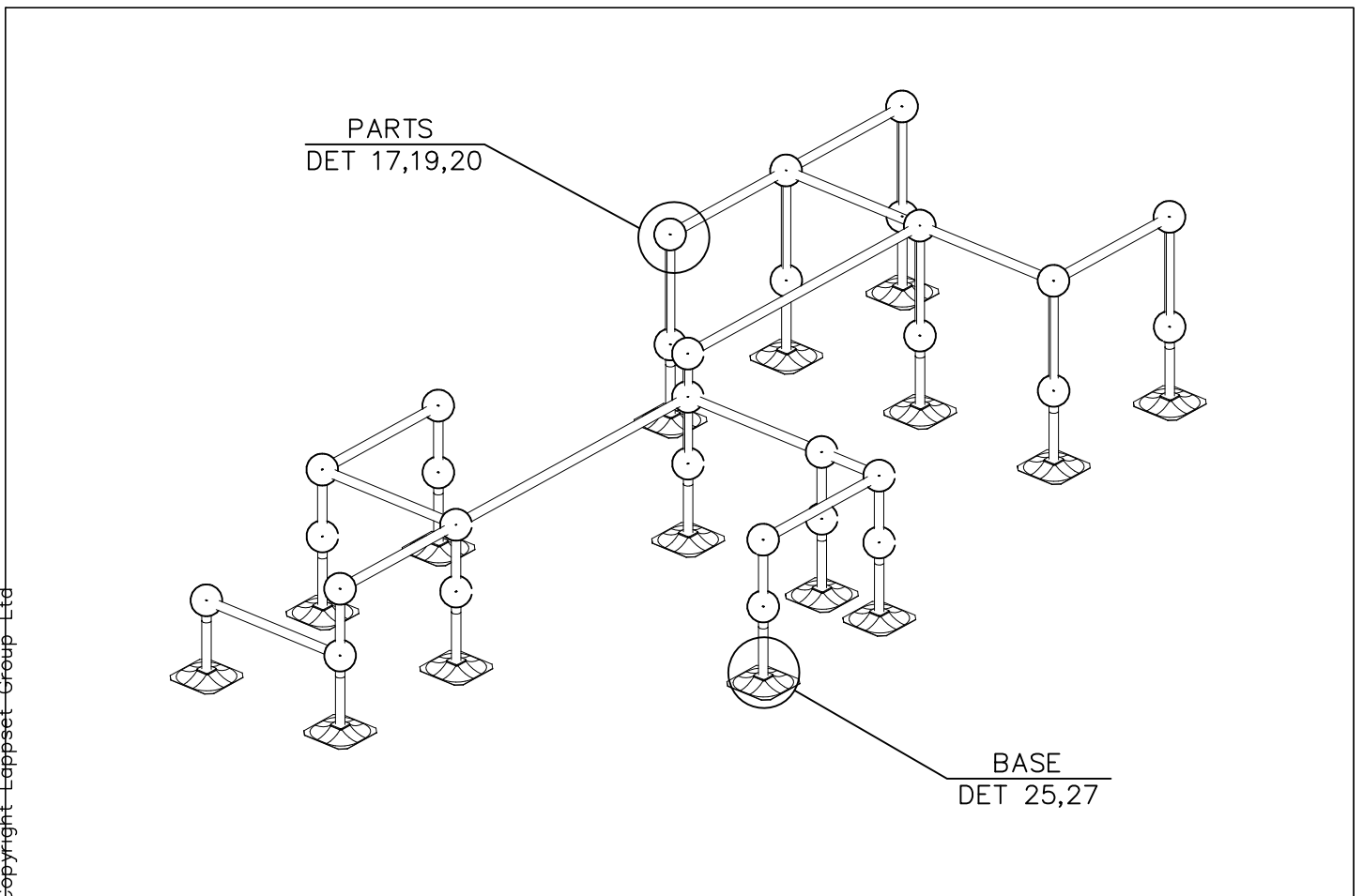
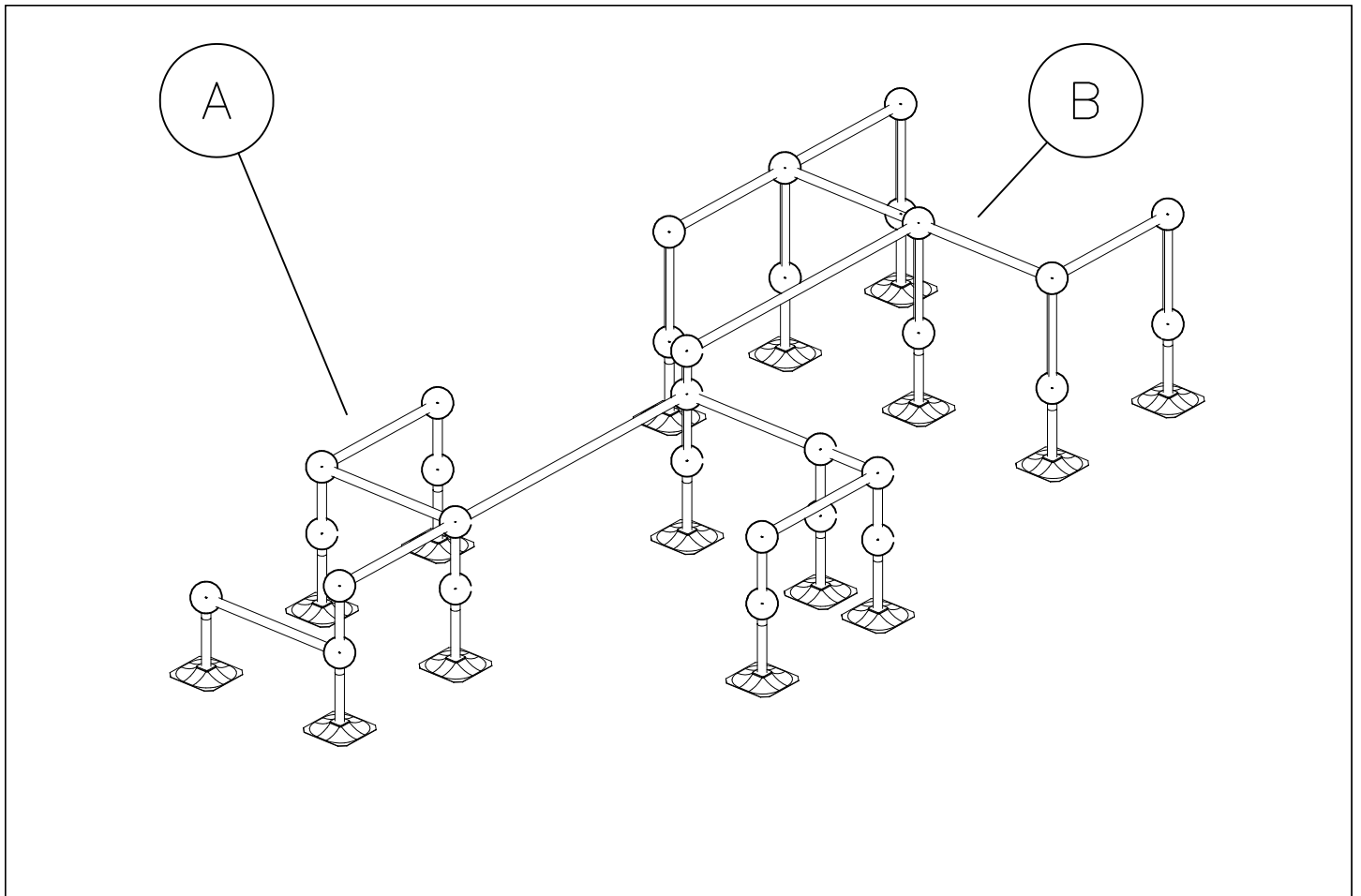

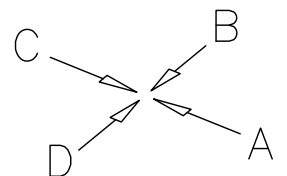
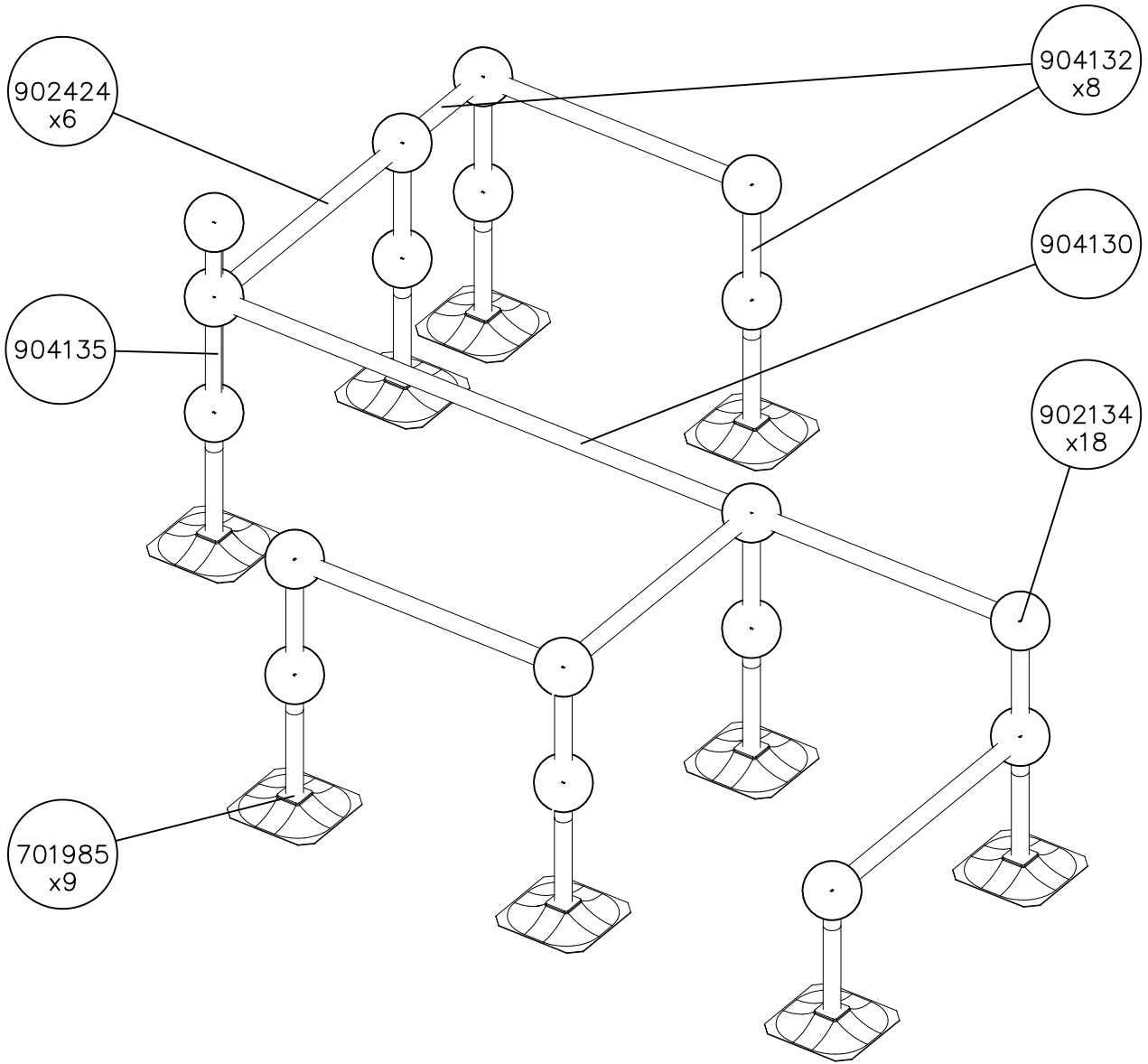

DATE: 8.2.2013

1:50

(A)

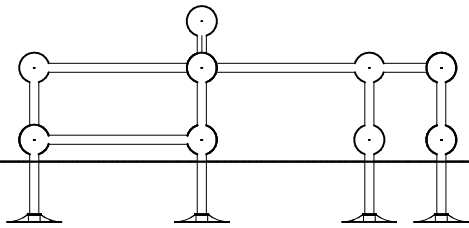

(B)

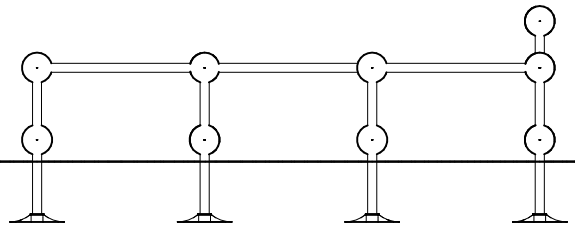

(C)

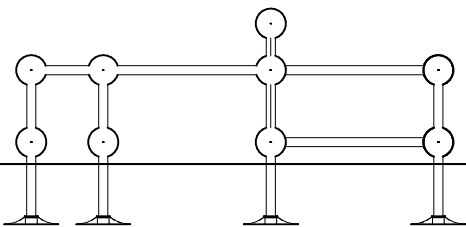

(D)

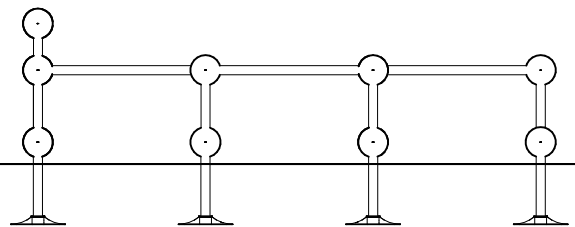

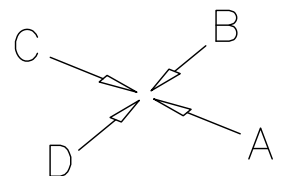
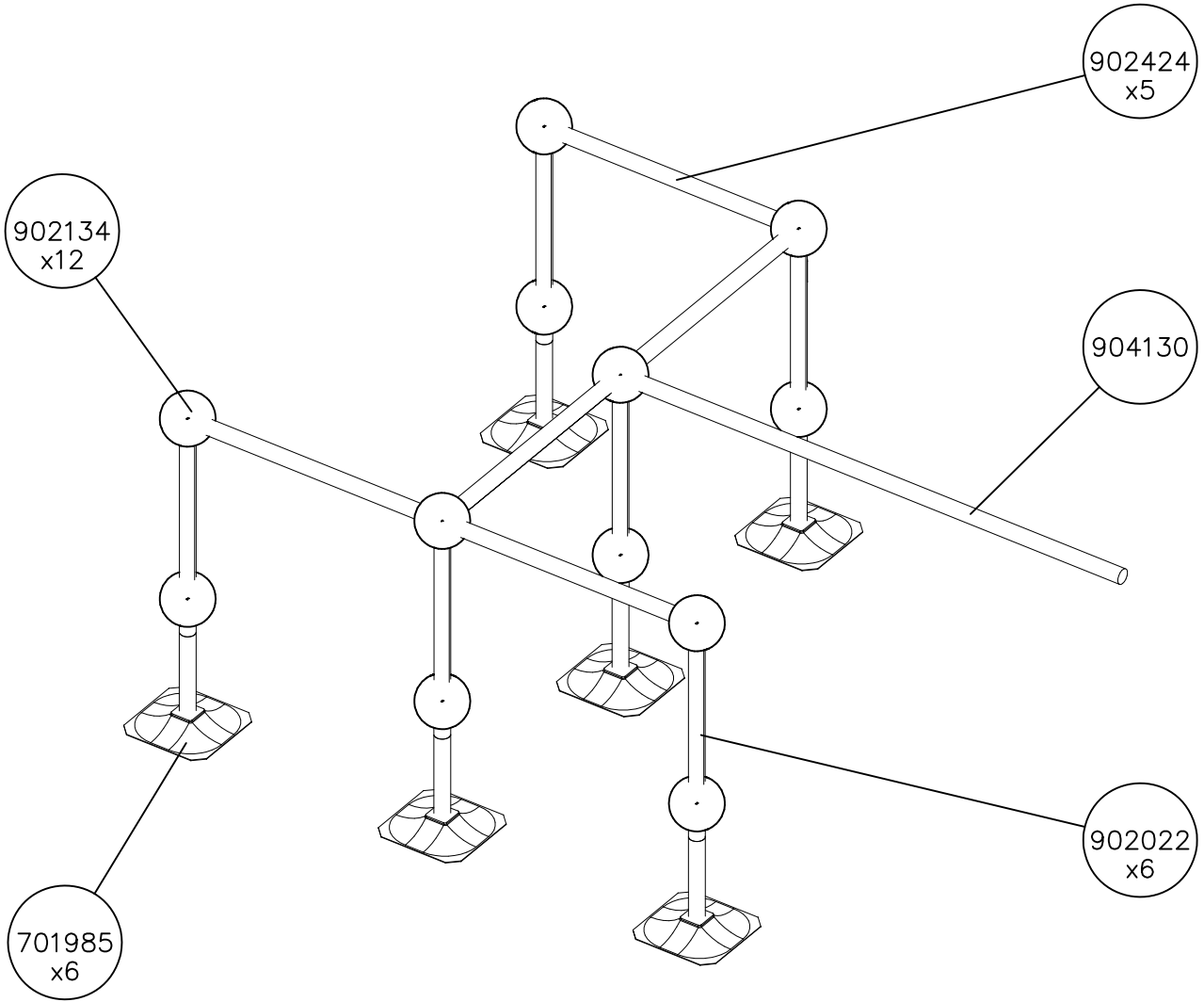

DATE: 8.2.2013

1:50

(A)

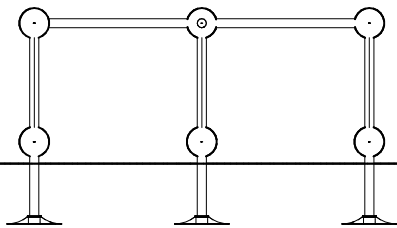

(B)

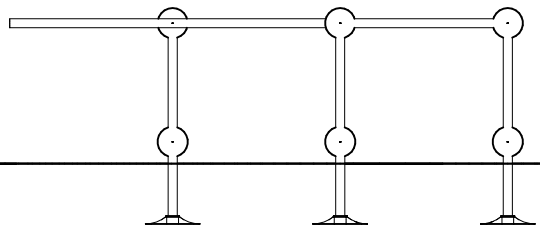

(C)

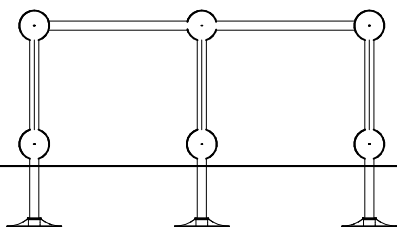

(D)

